

IKO

C-Sleeve Linear Way ML

Ceramic Ball Specification

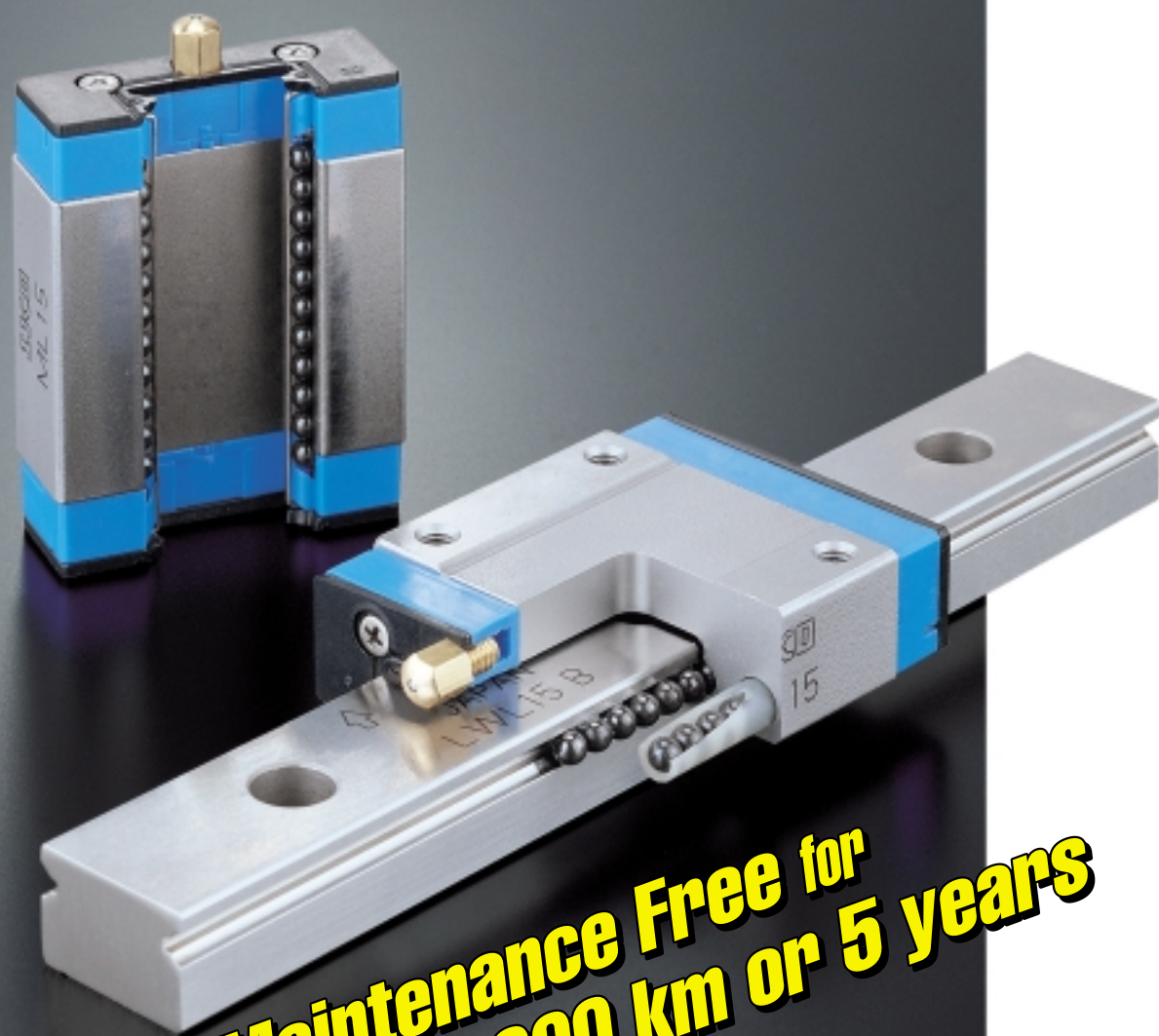

**Maintenance Free for
 20,000 km or 5 years**

CAT-5946



NIPPON THOMPSON CO., LTD.

Head office : 19-19 Takanawa 2-chome
 Minato-ku, Tokyo 108-8586, Japan
 Phone : +81 (0)3-3448-5850
 Fax : +81 (0)3-3447-7637
 E-mail : ntt@ikonet.co.jp
 URL : <http://www.ikont.co.jp/eg/>
 Plant : Gifu, Kamakura

Nippon Thompson Co., Ltd.

- ASEAN REPRESENTATIVE OFFICE
 586 Luang Road, Pomprab
 Pomprab Satrupai, Bangkok
 Thailand 10100
 Phone: +66 (0)-2623-3699
 Fax: +66 (0)-2623-0716
 E-mail: iko@anet.net.th
- CHINA REPRESENTATIVE OFFICE
 Shanghai Apollo Business Center 619
 1440 Yan An C. Road, Shanghai 200040
 People's Republic of China
 Phone: +86 (0)21-6248-6854
 Fax: +86 (0)21-6248-4782

IKO International, Inc.

- 91 Walsh Drive
 Parsippany, NJ 07054
 U.S.A.
 Phone: +1 973-402-0254
 Toll Free: 1-800-922-0337
 Fax: +1 973-402-0441
 E-mail: eco@ikonet.co.jp
- 500 East Thorndale Avenue
 Wood Dale, IL 60191
 U.S.A.
 Phone: +1 630-766-6464
 Toll Free: 1-800-323-6694
 Fax: +1 630-766-6869
 E-mail: mwo@ikonet.co.jp
- 20170 South Western Avenue
 Torrance, CA 90501
 U.S.A.
 Phone: +1 310-609-3988
 Toll Free: 1-800-252-3665
 Fax: +1 310-609-3916
 E-mail: wco@ikonet.co.jp
- 2150 Boggs Road, Suite 100
 Duluth, GA 30096
 U.S.A.
 Phone: +1 770-418-1904
 Toll Free: 1-800-874-6445
 Fax: +1 770-418-9403
 E-mail: seo@ikonet.co.jp
- 8105 N. Beltline Road
 Suite 130, Irving, TX 75063
 U.S.A.
 Phone: +1 972-929-1515
 Toll Free: 1-800-295-7886
 Fax: +1 972-915-0060
 E-mail: swo@ikonet.co.jp

Nippon Thompson Europe B.V.

- Sheffieldstraat 35-39
 3047 AN Rotterdam
 The Netherlands
 Phone: +31 (0)10-4626868
 Fax: +31 (0)10-4626099
 E-mail: nte@ikonet.co.jp
- Mündelheimer Weg 56
 40472 Düsseldorf
 Germany
 Phone: +49 (0)211-414061
 Fax: +49 (0)211-427693
 E-mail: ntd@ikonet.co.jp
- Im Gewerbepark D 30
 93059 Regensburg
 Germany
 Phone: +49 (0)941-206070
 Fax: +49 (0)941-2060719
 E-mail: ntdr@iko-nt.de
- Gruben Str. 95c
 66540 Neunkirchen
 Germany
 Phone: +49 (0)6821-999-860
 Fax: +49 (0)6821-999-8626
 E-mail: ntdn@iko-nt.de
- 2 Vincent Avenue, Crownhill
 Milton Keynes Bucks MK8 OAB
 United Kingdom
 Phone: +44 (0)1908-566144
 Fax: +44 (0)1908-565458
 E-mail: sales@iko.co.uk
- Autovia Madrid-Barcelona, Km. 43,700
 Polig. Ind. AIDA, A-8, Ofic. 2, 1ª
 19200-Azuqueca de Henares
 Guadalajara, Spain
 Phone: +34 949-263390
 Fax: +34 949-263113
 E-mail: nts@ikonet.co.jp
- Roissypole Le Dôme
 2 rue de La Haye
 BP 15950 Tremblay en France
 95733 Roissy C. D. G. Cedex
 France
 Phone: +33 (0)1-48165739
 Fax: +33 (0)1-48165746
 E-mail: ntf@ikonet.co.jp

Although all data in this catalog has been carefully compiled to make the information as complete as possible, NIPPON THOMPSON CO., LTD. shall not be liable for any damages whatsoever, direct or indirect, based upon any information in this catalog. NIPPON THOMPSON CO., LTD. makes no warranty, either express or implied, including the implied warranty of merchantability or fitness for a particular purpose.

IKO C-Sleeve Linear Way

Maintenance Free

Ability of lubrication is maintained for long term and allows cost reduction in lubrication management and systems.

Compact

No increase in carriage length unlike a bolt-on external lubrication components. No loss of available stroke length when replacing standard units.

Ecology

C-Sleeve contributes to global environment protection as the amount of lubricant can be minimized.

Smooth

Light and smooth running is achieved by the improvement of internal design. C-Sleeve does not have contact to track rail and creates no additional frictions.

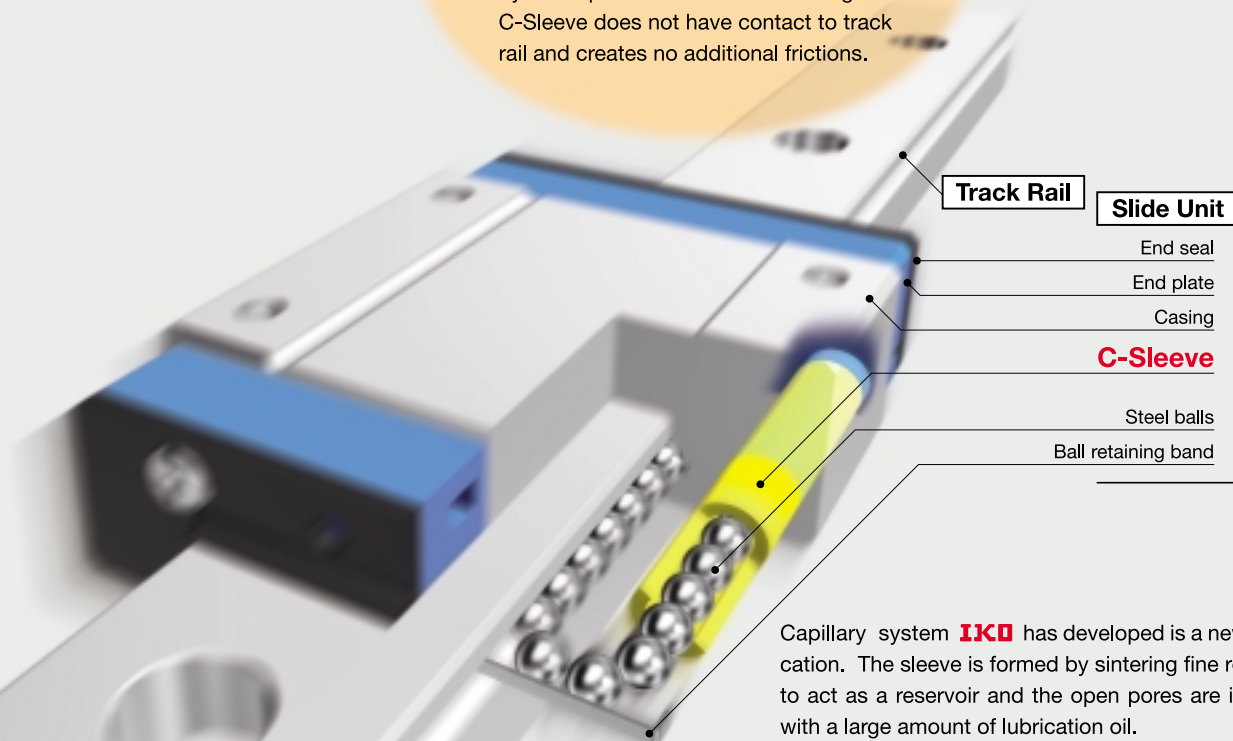

Capillary system **IKO** has developed is a new type lubrication. The sleeve is formed by sintering fine resin powder to act as a reservoir and the open pores are impregnated with a large amount of lubrication oil. The capillary action will then deposit the appropriate amount of lubrication on to the rolling elements to protect raceway surfaces.

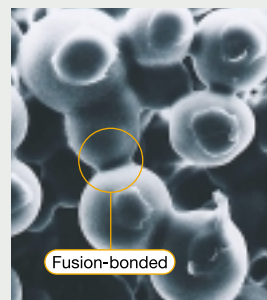

Before impregnating oil
Resin particles are strongly fusion-bonded.

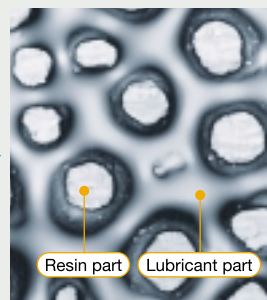

After impregnating oil
(Capillary lubrication structure)
Lubricant is retained in cavities amongst resin particles.



Features of C-Sleeve Linear Way

Maintenance Free for saving-resources

Maintenance Free has the ability to maintain lubrication for a long time, reducing the amount of labor required for troublesome lubrication maintenance. The capillary lubrication body keeps supplying lubricant for long period of time even after original grease inside of the slide unit is completely exhausted.

※ This durability test has been simulated for general use.
Re-lubrication may necessary if operating condition is extremely severe.

Ecological contribution to the global environment by conserving oil

To accomplish this, C-Sleeve applies only the minimal amount of lubricant to the rolling parts required for the properly lubrication. Since the oil consumption is small, C-Sleeve is able to maintain proper lubrication even in long-term operation.

Smooth and light operation

C-Sleeve has no contact with the track rail. This permits smooth and light sliding motion without increasing the rolling resistance. The power loss of a driving device can be minimized. Compatibility of quick response is superior and it contributes accuracy improvement and saving driving energy.

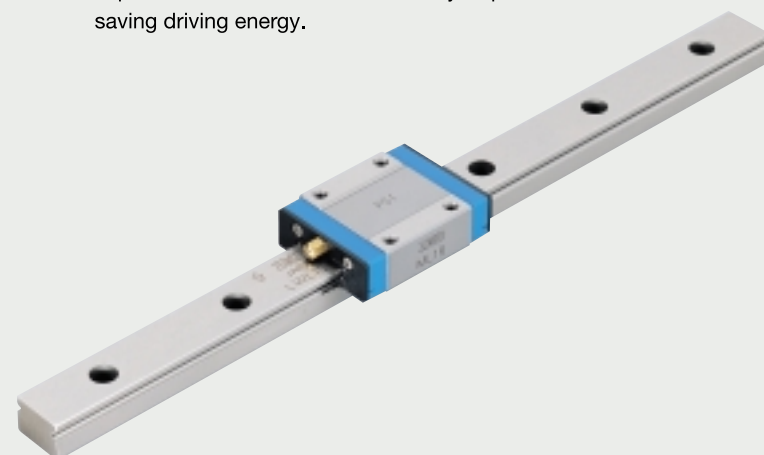
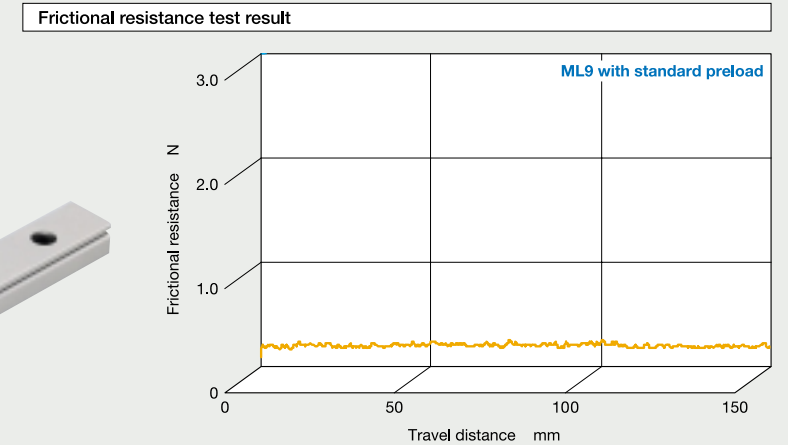
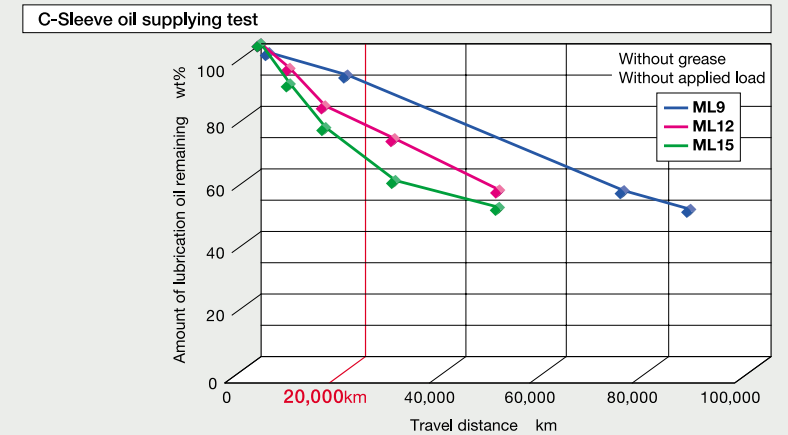
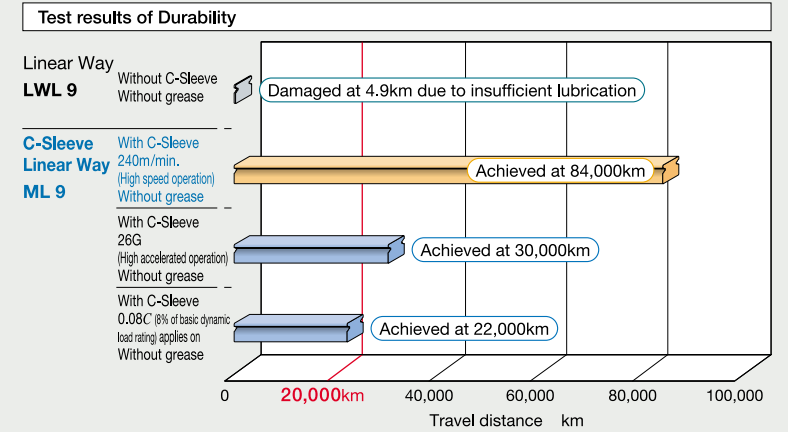

1N=0.102kgf=0.2248lbs.
1mm=0.03937inch

IKO C-Sleeve Linear Way ML with Ceramic Ball Specification

ML.../HB

Silicon nitride ceramics balls are incorporated in the slide unit to realize high-speed operation and low running noise. In addition, the rigidity has been improved because of the minimal elastic deformation of ceramic characteristic.

Structure

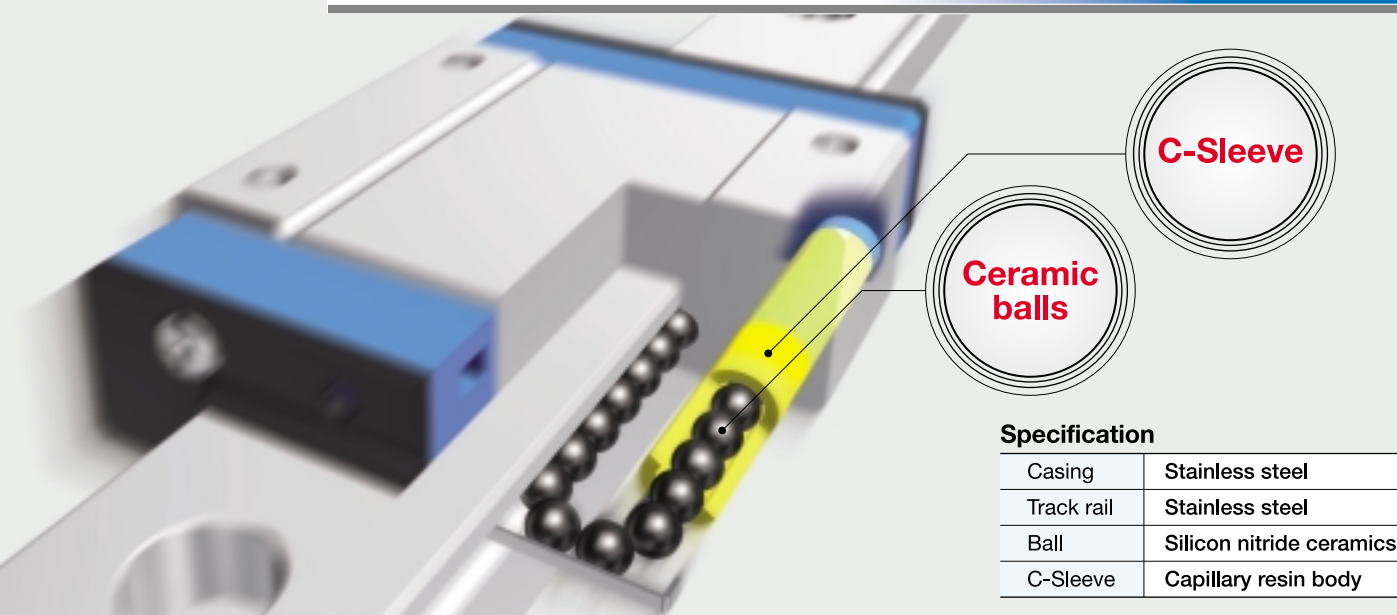

Specification	
Casing	Stainless steel
Track rail	Stainless steel
Ball	Silicon nitride ceramics
C-Sleeve	Capillary resin body

Features

- High Speed Operation**
Three times of durability
- Low Running Noise**
Approximately 4.5dB
- High Rigidity**
Deformation reduced by 10%
- High Wear Resistance**
Wear resistance improved by four times

Maintenance Free

Ability of lubrication is maintained for 5 years or 20,000 km.
Cost of lubrication management and system can be reduced.

Compact

No increase in length of slide unit
No loss of available stroke length

Ecology

For the global environment protection

Smooth

Very light running motion

Performance

High-Speed Operation

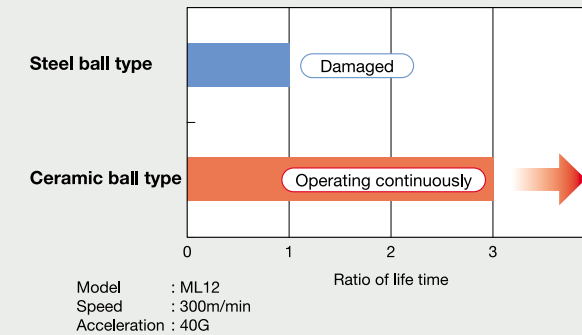

Low Noise in Operation

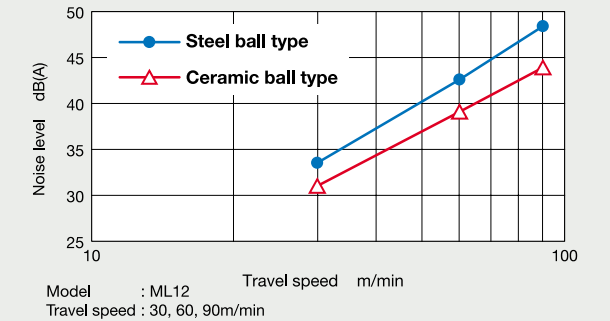

High Rigidity

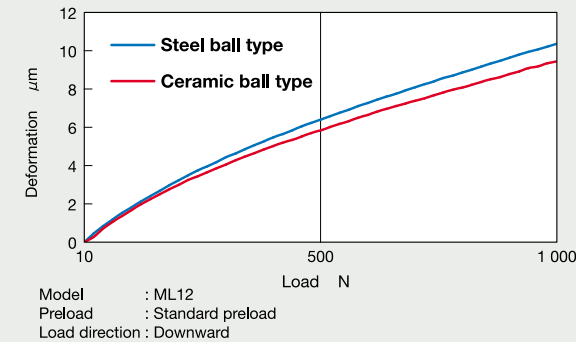

Wear Resistance

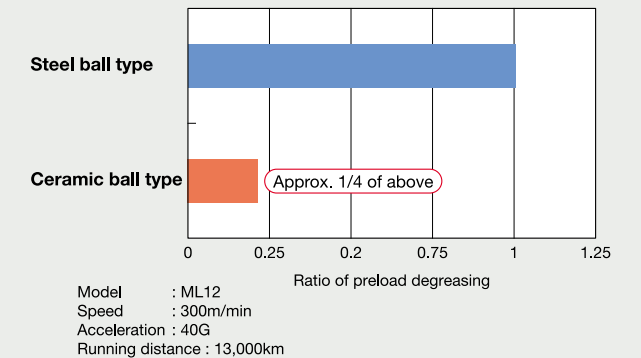

Lubricant supply mechanism of C-Sleeve system

The circulation of the balls distributes lubricant.

Lubricant is supplied directly to the balls. As the balls circulate, the lubricant is distributed to the loading area along the track rail. This results adequate lubrication maintained in the loading area for a long time.

Lubricant is deposited directly to the surface of the balls.

The surface of C-Sleeve is always covered with the lubricant. Lubricant is continuously supplied to the surface of ball by surface tension in the contact of C-Sleeve surface and balls. New oil permeates automatically from the core of C-Sleeve to the internal surface that comes in contact with balls.

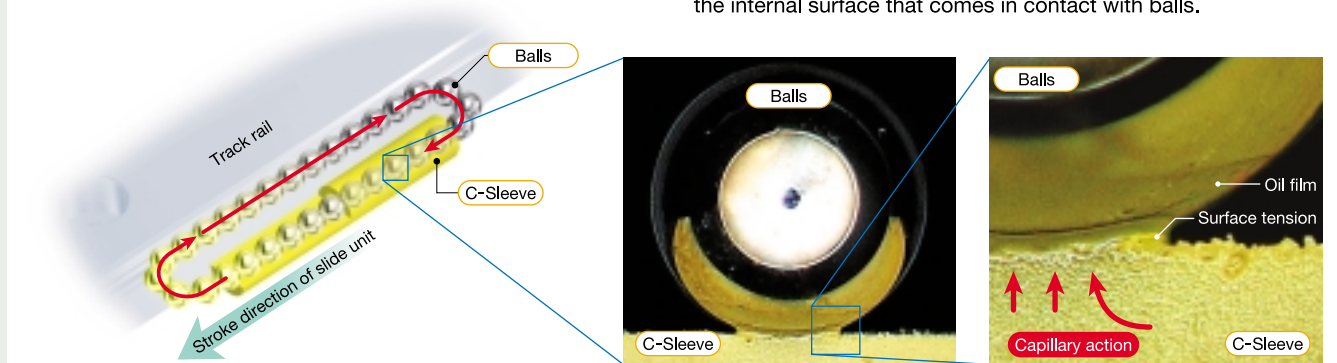

1N=0.102kgf=0.2248lbs.
1mm=0.03937inch

IKO C-Sleeve Linear Way ML Ceramic ball specification

MLC·ML·MLG···/HB

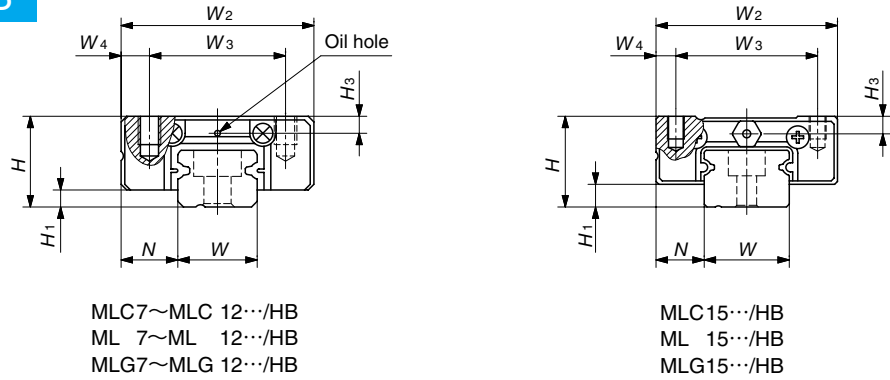

Model number	Mass (Reference) g		Dimension of assembly mm			Dimension of slide unit mm									
	Slide unit	Track rail (per 100mm)	H	H ₁	N	W ₂	W ₃	W ₄	L ₁	L ₂	L ₃	L ₄	M ₁ ×depth	H ₃	W
MLC 7···/HB	6.1	22	8	1.5	5	17	12	2.5	19	—	9.6	—	M2×2.5	1.5	7
ML 7···/HB	8.4								23.5	8	14.3				
MLG 7···/HB	12								31	12	21.6				
MLC 9···/HB	11	35	10	2	5.5	20	15	2.5	21.5	—	11.9	—	M3×3	2.2	9
ML 9···/HB	17								30	10	20.8				
MLG 9···/HB	25								40.5	15	30.9				
MLC 12···/HB	20	65	13	3	7.5	27	20	3.5	25	—	13	—	M3×3.5	2.7	12
ML 12···/HB	31								34	15	21.6				
MLG 12···/HB	44								44	20	32				
MLC 15···/HB	40	107	16	4	8.5	32	25	3.5	32	—	17.8	36	M3×4	3.1	15
ML 15···/HB	58								42	20	27.9	47			
MLG 15···/HB	86								57	25	42.8	62			

Note (1) : The directions of basic dynamic load rating (C), basic static load rating (C₀) and static moment rating (T₀, T_x and T_y) are shown in the sketches below.

The upper values in the T_x and T_y column apply to one slide unit, and the lower values apply to two units in close contact.

Remarks 1 : The appended bolts for mounting track rails are hexagon socket head bolts of JIS B1176 or equivalent, or cross-recessed head cap screws for precision equipment.

2 : Oil hole is provided for ML7 to ML12 models.

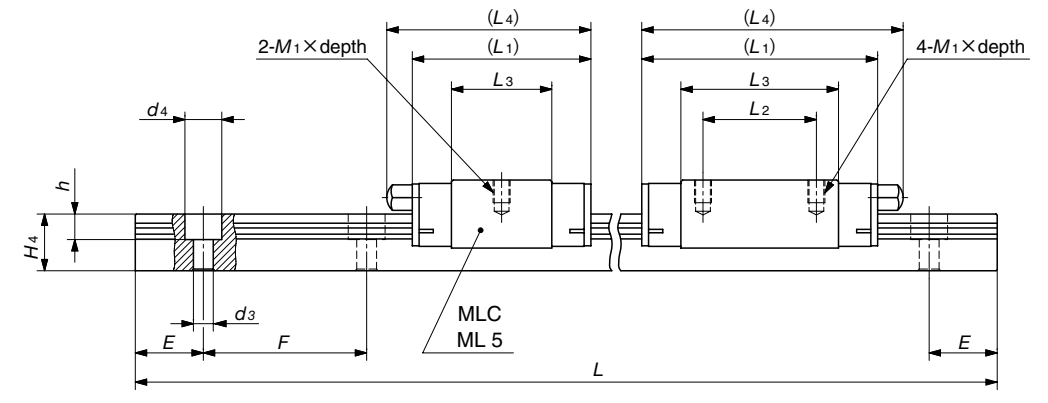
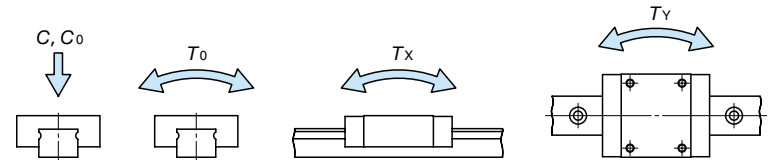

Dimension of track rail mm						Included mounting bolt for track rail mm Bolt size x length	Basic dynamic load rating (1) C N	Basic static load rating (1) C ₀ N	Static moment rating (1)			Model number
H ₄	d ₃	d ₄	h	E	F				T ₀ N·m	T _x N·m	T _y N·m	
5	2.4	4.2	2.3	7.5	15	Hexagon socket head bolt M2×6	937	965	3.5	1.6	1.3	MLC 7···/HB
							1 330	1 610	5.9	4.0	3.3	ML 7···/HB
							1 690	2 250	8.2	7.5	6.3	MLG 7···/HB
6	3.5	6	3.5	10	20	Hexagon socket head bolt M3×8	1 180	1 260	5.9	2.4	2.1	MLC 9···/HB
							1 810	2 340	10.9	7.7	6.5	ML 9···/HB
							2 370	3 420	15.9	15.9	13.4	MLG 9···/HB
8	3.5	6.5	4.5	12.5	25	Hexagon socket head bolt M3×8	2 210	2 030	12.6	4.5	3.8	MLC 12···/HB
							3 330	3 650	22.6	13.1	11.0	ML 12···/HB
							4 310	5 270	32.7	26.0	21.9	MLG 12···/HB
10	3.5	6.5	4.5	20	40	Hexagon socket head bolt M3×10	3 490	3 310	25.5	9.9	8.3	MLC 15···/HB
							4 980	5 520	42.5	25.3	21.2	ML 15···/HB
							6 620	8 280	63.7	54.3	45.5	MLG 15···/HB

Example of identification number of assembled set

